

QUEST 876

For complete product
information, scan here:



- + Largest Capacity
- + Industry-Leading Efficiency
- + Patented M-CoRR Technology
- + Superior MERV-13 Air Filtration
- + Integrated Lift and Hang Points
- + Auto-Restart After Power Outages

Serial Number _____

Install Date _____

Sold By _____



Patents: thermastor.com/patents

TABLE OF CONTENTS

- Safety Precautions2
- 1. Intended Application.....3
- 2. Registrations3
- 3. Specifications.....3
- 4. Installation4
 - 4.1 Location.....4
 - 4.2 Electrical Requirements4
 - 4.3 Condensate Water Removal5
 - 4.4 Hanging5
- 5. Controls.....6
 - 5.1 Humidity Control.....6
 - 5.2 24VAC Wiring6
 - 5.2A Deh 3000R.....7
 - 5.2B Honeywell Remote Humidistat7
 - 5.2C Daisy Chain.....7
- 6. Maintenance7
 - 6.1 Standard Air Filter.....8
- 7. Service.....8
 - 7.1 Warranty.....8
 - 7.2 Technical Description8
 - 7.3 Troubleshooting.....8
- 8. Ducting Guidelines.....10
- 9. Display.....11
- Wiring Diagram.....15
- Service Parts List.....16
- Optional Parts List.....16
- Warranty.....18



SAFETY PRECAUTIONS

Read the installation, operation and maintenance instructions carefully before installing and operating this device. Proper adherence to these instructions is essential to obtain maximum benefit from your Quest Dehumidifier.

READ AND SAVE THESE INSTRUCTIONS

- » The device is designed to be installed **INDOORS IN A SPACE THAT IS PROTECTED FROM RAIN AND FLOODING.**
- » Install the unit with space to access the back or side panels for maintenance and service. **DO NOT INSTALL UNIT WITH THE SERVICE PANELS INACCESSIBLE.**
- » Avoid directing the discharge air at people, or over the water in pool areas.
- » If used near a pool, spa or water; be certain there is **NO** chance the unit could fall into the water, be splashed and that it is plugged into an outlet that is a **GROUND FAULT INTERRUPT** protected circuit.
- » **DO NOT** use the device as a bench or table.
- » **DO NOT** place the device directly on structural members. Provide vibration isolation in order to minimize operational vibration and/or noise.
- » A drain pan **MUST** be placed under the unit if installed above a living area or above an area where water leakage could cause damage
- » Never operate a unit with a damaged power cord. If the power cord is damaged it must be replaced by the manufacturer, its service agent, or similarly qualified person in order to avoid a hazard.
- » Make all electrical connections in accordance with the current edition of the **NEC ANSI/NFPA 70** and any national and local codes or ordinances that may apply.
- » Maintain a minimum **3ft. (1m)** clearance to avoid obstructing the air return and supply.
- » This appliance is not intended for use by persons (including children) with reduced physical, sensory or mental capabilities, or lack of experience and knowledge, unless they have been given supervision or instruction concerning use of the appliance by a person responsible for their safety. Children should be supervised to ensure that they do not play with the appliance.
- » Not intended for use at altitudes over **2000M.**

1. INTENDED APPLICATION FOR QUEST 876

The Quest 876 Dehumidifier is designed to operate in temperatures between 56 F and 95 F.

In order to efficiently control humidity levels, the area in which the dehumidifier is to be operated must be free of water intrusion or excessive fresh (outside) air infiltration. Before installing the Quest 876 Dehumidifier, water intrusion and air infiltration problems should be addressed or noted in calculations.

2. REGISTRATIONS

The Quest 876 Dehumidifier units conform to unified standards: UL 60335-2-40, CSA 22.2 # 60335-2-40:2012 Ed. 1+4. Patent: thermastor.com/patents

3. SPECIFICATIONS @ 80°F / 60% RH

UNIT	QUEST 876 4037600	
CFM:	1850 @ 0.0" WG	
POWER:	5500 Watts	
SUPPLY VOLTAGE:	220-240 VAC 1 Phase - 60 Hz	
CURRENT DRAW:	24.7A	
RATED CURRENT DRAW (AMPS): (104 F 36%)	34.6A	
MCA*	42.5A	
MOP*	70A	
RECOMMENDED BREAKER SIZE:	45A	
ENERGY FACTOR:	3.1 L/kWh	
OPERATING TEMP:	56 F Min - 95 F Max	
WATER REMOVAL: EFFICIENCY:	876 Pints/Day 6.6 Pints/kWh	
AIR FILTER (MERV-13): (QTY 2)	Size: 18" x 20" x 2"	
POWER CORD:	None. Hardwire only.	
DRAIN CONNECTION:	3/4" Threaded NPT	
REFRIGERANT TYPE:	R410A	
REFRIGERANT AMOUNT:	6 lb 4 oz	
DIMENSIONS:	Unit	Shipping
WIDTH:	28.9"	36"
HEIGHT:	34.1"	40"
LENGTH:	44.8"	48"
WEIGHT:	340 lb	420 lb

NOTES:

Unit 4037600 requires buck/boost transformer to run on 208V or 277V.

Unit requires external control, not provided.

* MCA = Minimum Circuit Ampacity

This number provides a qualified electrician with the information needed to determine the minimum wire size used in the circuit that feeds a single dehumidifier.

* MOP = Maximum Overcurrent Protection

This number provides a qualified electrician with the value of the maximum size circuit breaker that may be used to protect the circuit that feeds a dehumidifier.

Specifications are subject to change without notice.

4. INSTALLATION

4.1 LOCATION

The Quest 876 Dehumidifier can be installed in a variety of locations to meet the owner's needs as listed below. In all cases keep the following cautions in mind:

- » It is designed to be installed INDOORS IN A SPACE THAT IS PROTECTED FROM RAIN AND FLOODING.
- » Install the unit with space to access side panel for maintenance and service. DO NOT INSTALL UNIT WITH ACCESS PANEL INACCESSIBLE.
- » Avoid discharging the air directly at people, or over the water in pool areas.
- » Be certain there is NO chance the unit could fall into water or be splashed and that it is plugged into a GROUND FAULT INTERRUPTER.
- » DO NOT use the Quest 876 Dehumidifier as a bench or table.
- » DO NOT place the Quest 876 Dehumidifier directly on structural members. Provide vibration isolation in order to minimize operational vibration and/or noise.
- » A drain pan MUST be placed under the unit if installed above an area where water leakage could cause damage.
- » DO NOT obstruct the supply or return air. Maintain a minimum 3' clearance around supply and return air.

4.2 ELECTRICAL REQUIREMENTS

 **WARNING!** Electrical shock hazard: Electrical power must be present for some test. These test should be performed by a qualified service person.

The Quest 876 dehumidifier plugs into NEMA 6-20R rated receptacle. The Quest 876 277v dehumidifier plugs into a NEMA L7-20P rated receptacle. The amp draws are listed on page 4 of this manual. Connecting to electrical power must comply with all national, state and local electrical codes. A ground fault interrupter protected circuit is recommended. This unit shall not be used with an extension cord.

 **WARNING!** The On/Off switch above the 24VAC control reset only turns off the 24VAC circuit. It does not disconnect the main power.

Low Voltage Connections

Install the external control in a central area of the structure where it will sense the relative humidity accurately. Do not install the control sensor where it may not accurately measure the relative humidity such as near HVAC supply registers, near exterior doors or near pool or spas. The installer must supply the wiring between the dehumidifier and the external control. Be sure to safely route the control wiring to prevent damage during installation. Be careful not to cross the wires when connecting the dehumidifier and the external control.

The controls of the dehumidifier are powered by a low voltage circuit (24VAC) and must NEVER contact or be connected to a high voltage circuit. The control terminals are labeled to prevent confusion.

 **WARNING!** Damaged power cords can only be replaced with one by the unit manufacturer.

4.3 CONDENSATE WATER REMOVAL

Condensate drains by gravity via the drain port. Use 3/4" male NPT PVC pipe. An optional condensate pump kit may be installed if a lift is required to dispose of the condensate. Optional parts list for information on the kit.

FOLLOW DIAGRAM:

- » Level within 2°

Vent:

- » Place vent after the trap.
- » Vent should be open.
- » Height of vent should be higher than drain outlet.

Cap:

- » A clean out can be placed before trap but must be sealed with a cap.

Drain Line:

- » Drain line should go in a downward slope to the drain.
- » 1/4" drop per foot.

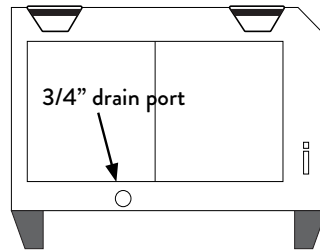

Drain Trap Configuration

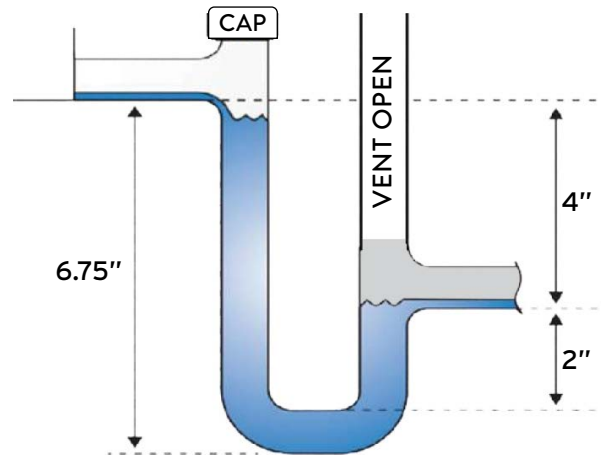

4.4 HANGING DIAGRAM

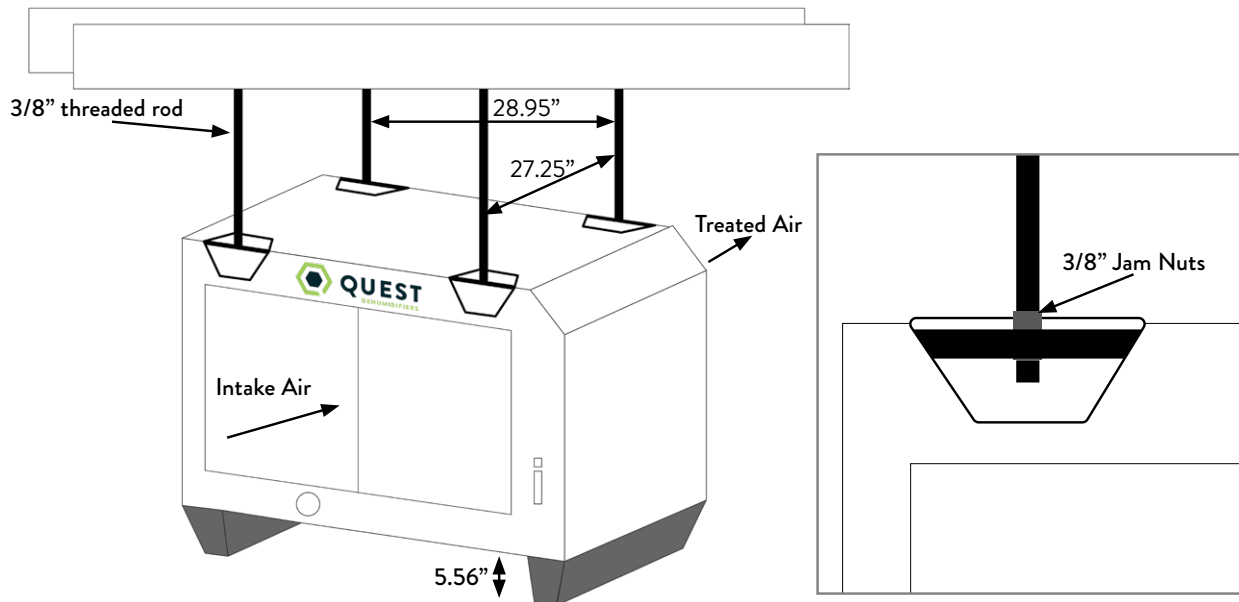

- PARTS NEEDED:**
- 4 pieces 3/8" threaded rod (not included)
 - 4 - 3/8" threaded jam nuts (not included)

⚠️ WARNING! Hanging installation must meet all state and local codes.

⚠️ WARNING! Installation should be done by a qualified agency in accordance with these instructions. The qualified service agency installing this high efficiency refrigeration system is responsible for the installation.

⚠️ WARNING! Check the supporting structure to be used to verify that it has sufficient load carrying capacity to support the weight of the unit. Suspend the unit only from the threaded nut retainers. Do NOT suspend from the cabinet.

⚠️ CAUTION! Recommended maximum hanger rod is 6 feet (1.8m).

5. CONTROL OPTIONS

The Quest 876 Dehumidifier is controlled by an external remote humidistat through a 24V terminal block. External control NOT provided.

5.1 HUMIDITY CONTROL

A 24VAC signal is sent by the remote humidistat signals the fan or fan and compressor to actuate.

QUEST CONTROL OPTIONS:

- Cloud Control
- Quest DEH300OR
- Honeywell Humidipro
- Any 24V signal to Dehumidify

⚠️ CAUTION! Low Voltage Hazard. Can cause equipment damage. Disconnect power before beginning installation.

5.2 24VAC WIRING

The terminal block, low voltage circuit breaker, and power switch are located on the intake side of the unit. Turn the power switch to the off position while wiring the unit.

FLOAT: {External normally closed dry contact float switch.} No voltage may be applied to the float switch.

FLOAT: Applying voltage may damage the control and void the warranty. {If no float is used in the system, leave the jumper connected to the terminal block}

DEHU: Dehumidification (compressor and fan operation)

R: 24VAC output

FAN: Fan operation only

C: 24VAC neutral (common)

Note:

External devices can be powered between 24V/COM (10VA max).
24V circuit is protected by circuit breaker.

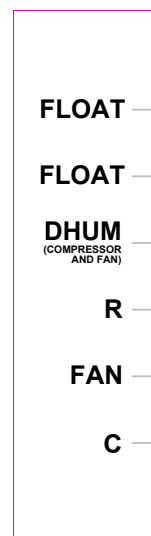

5.2A CLOUD CONTROL

QUEST CLOUD CONTROL WIRING DIAGRAM

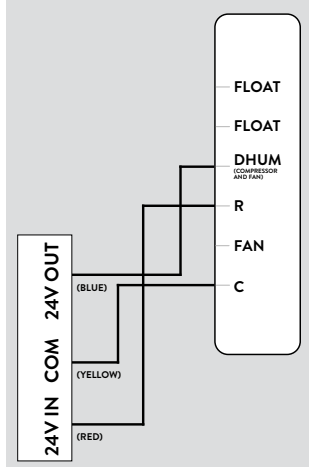

5.2A DEH 3000R CONTROL

QUEST DEH 3000R CONTROL WIRING DIAGRAM

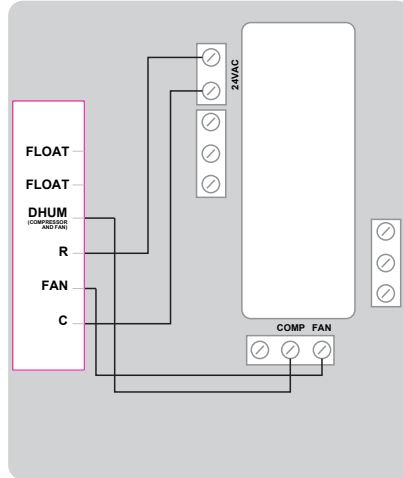

5.2B HONEYWELL REMOTE HUMIDISTAT

HONEYWELL REMOTE HUMIDISTAT WIRING DIAGRAM

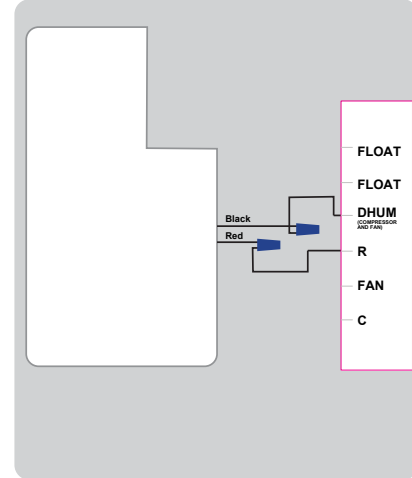

5.2C DAISY CHAIN

QUEST DEH 3000R CONTROLLER

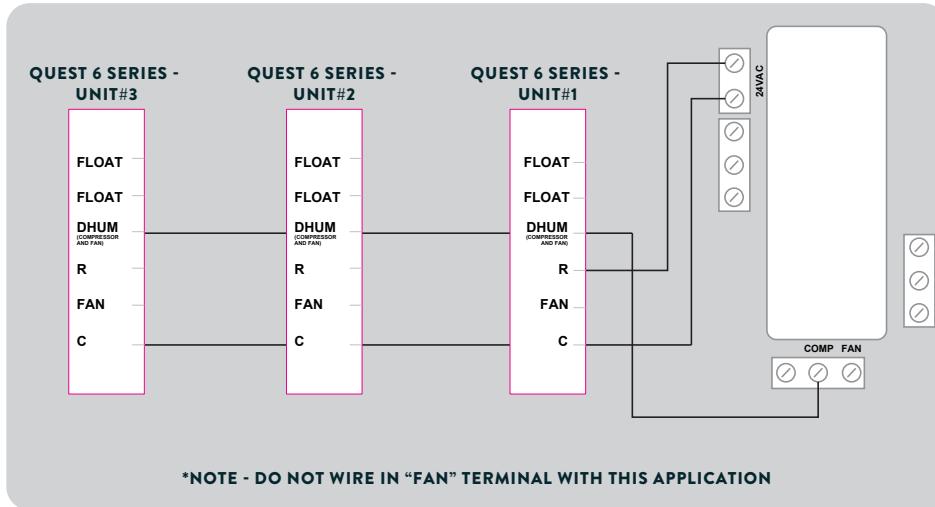

6. MAINTENANCE

⚠ WARNING! Do not operate the unit without the filter or with a less effective filter. The heat exchange coils inside the unit could become clogged and require disassembly to clean. Filter non-compliance invalidates the product warranty.

6.1 STANDARD AIR FILTER

The Quest 876 Dehumidifier ships with a standard MERV-13 efficient pleated fabric filter. This filter should be checked every six months. Operating the unit with a dirty filter will reduce dehumidifier capacity and efficiency and may cause the compressor to cycle off and on unnecessarily on the defrost control.

To access the air filter, the filter should be readily visible and can be removed by pulling it straight out of the Quest 876 Dehumidifier.

We recommend changing the filter at least with every grow cycle.

7. SERVICE

⚠️ WARNING! Servicing the Quest 876 with its high pressure refrigerant system and high voltage circuitry presents a health hazard which could result in death, serious bodily injury, and/or property damage. Only qualified service people should service this unit.

7.1 WARRANTY

A warranty certificate has been enclosed with this unit; read it before any repair is initiated. If a warranty repair is required, call the factory first at 1-877-420-1330 for warranty claim authorization and technical assistance.

7.2 TECHNICAL DESCRIPTION (NON STANDARD PATENTED)

The Quest 876 Dehumidifier uses a refrigeration system similar to an air conditioner's to remove heat and moisture from incoming air, and add heat to the air that is discharged.

Hot, high-pressure refrigerant gas is routed from the compressor to the condenser coil. The refrigerant is cooled and condensed by giving up its heat to the air that is about to be discharged from the unit. The refrigerant liquid then passes through a filter/drier and expansion drier which causes the refrigerant pressure and temperature to drop. It next enters the evaporator coil where the cool refrigerant absorbs heat from the incoming air and evaporates.

The compressor evacuates the cool refrigerant vapor from the evaporator and compresses it to a high pressure and temperature to repeat the process.

7.3 TROUBLESHOOTING

Neither fan nor compressor running. Dehumidification is being called for. No fan call.

1. Unit unplugged or no power to outlet.
2. Humidity control set too high.
3. Loose connection in internal or control wiring.
4. Defective Compressor relay.
5. Defective control transformer.

Compressor is not running. Dehumidification is being called for. No fan call.

1. Defective compressor run capacitor.
2. Loose connection in compressor circuit.
3. Defective compressor overload.
4. Defective compressor.
5. Defrost thermostat open.

Compressor cycles on and off. Dehumidification is being called for. Fan is running.

1. Low ambient temperature and/or humidity causing unit to cycle through defrost mode.
2. Defective compressor overload.
3. Defective compressor.
4. Defrost thermostat defective.
5. Dirty air filter(s) or air flow restricted.

Fan is not running. Dehumidification or fan is being called for.

1. Loose connection in fan circuit.
2. Obstruction prevents fan impeller rotation.
3. Defective fan.
4. Defective fan relay.

Low dehumidification capacity (evaporator is frosted continuously). Dehumidification is being called for.

1. Defrost sensor loose or defective.
2. Low refrigerant charge
3. Dirty air filter(s) or air flow restricted.
4. Excessively restrictive ducting connected to unit.

Unit removes some water, but not as much as expected.

1. Air temperature and/or humidity have dropped.
2. Humidity meter and or thermometer used are out of calibration.
3. Unit has entered defrost cycle.
4. Air filter dirty.
5. Defective defrost sensor.
6. Low refrigerant charge.
7. Air leak such as loose cover or ducting leaks.
8. Defective compressor.
9. Restrictive ducting.
10. Optional Condensate Pump Safety Switch open.

Test to determine if the problem is with the unit or control:

1. Detach field control wiring connections from unit.
2. Connect the 24V and FAN together; only the impeller fan should run. Disconnect the wires.
3. Connect the 24V and DEHU together; fan should run, Compressor should come on after a short delay.
4. Run the unit for 1 hour in an environment that is greater than a 50 F dew point. The unit should produce water from the drain port.
5. If these tests pass, the unit is working properly. You should check the control and field wiring for problems if the unit is not activating. Check for air restrictions, low temperature, low humidity and refrigerant charge if the unit is not producing water.

8. DUCTING GUIDELINES

⚠ CAUTION! Quest 876 is intended for use in statics under .25"WG.

- Use a minimum of two 12" diameter round ducts to duct the intake; intake duct kit available from Therma-Stor.
- Duct the exhaust using a singular rectangular plenum; exhaust duct kit available from Therma-Stor.
- Grills or diffusers on the duct ends must not excessively restrict airflow.
- Effective dehumidification may require ducting to be branched to isolated or stagnant flow areas. Be sure to use appropriate size duct branches to maintain proper feed throughout the ducting system.
- System control should be placed remotely from the dehumidifier in a central location.
- Intake and exhaust ducting should have a minimum of 4 feet from the unit before any turns.

⚠ CAUTION! Do not connect with a static pressure greater than +.25"wg. Contact technical support for additional details.

Optional duct kits are available from Therma-Stor: Exhaust Kit 4039868 and Intake Kit 4038642. See figures below for plenum dimensions and duct diameters. Alternatively, licensed contractors can fabricate duct plenums and reference figures below for safe fastener mounting points.

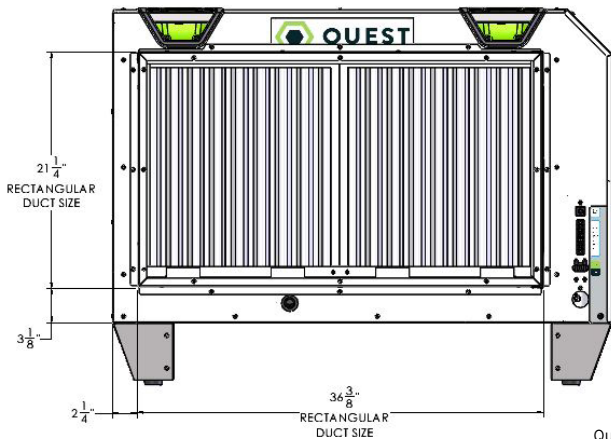

Quest 6 Series 706/876
Intake Duct Location

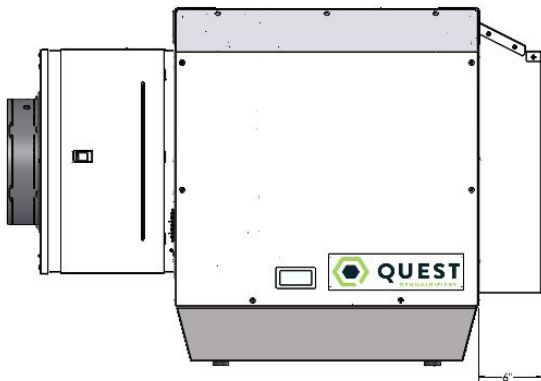
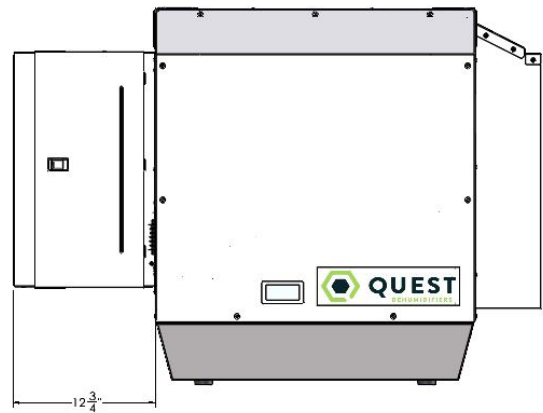

Quest 6 Series 706/876
Supply Duct Location

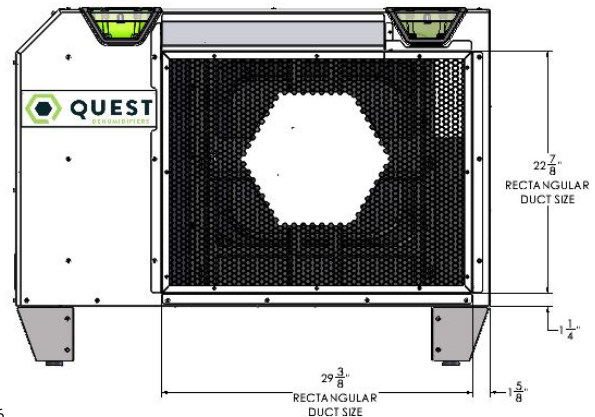

9. DISPLAY

9.1 USER INTERFACE

The main status screen is shown:



Left side buttons (top to bottom):

- **Alarm** - press at any time to check active alarms.
- **Prg/Bullseye** - press at any time to access settings and menus.
- **Escape** - press at any time to move to the previous menu.

Right side buttons (top to bottom)

- **Up**
 - » On a menu selection screen - moves cursor up.
 - » On an editable value - increases the value. Press and hold to change the value faster.
 - » If cursor is in upper left corner of a screen - moves to previous screen.
- **Enter**
 - » On a menu selection screen - enters the highlighted menu.
 - » On an editable value - saves the current value and moves to the next editable item on the screen.
- **Down**
 - » On a menu selection screen - moves cursor down.
 - » On an editable value - decreases the value. Press and hold to change the value faster.
 - » If cursor is in upper left corner of screen - moves to next screen.

9.2 SETTINGS CHANGE EXAMPLE: CHANGING DATE DISPLAY FORMAT

1. From any screen, press the Prg/Bullseye key. This will prompt for a password.

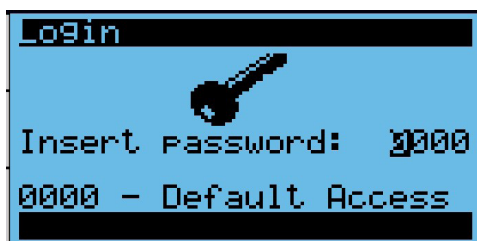

2. Press Enter four times to access the menu. Then, press Up/Down keys until Settings is highlighted.



3. Press Enter to enter Settings menu. Then, press Up/Down until Date/Time is highlighted.

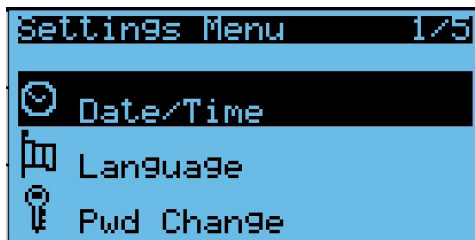

4. Press Enter to select Date/Time. Then, press Enter again to move the cursor to the Format field.

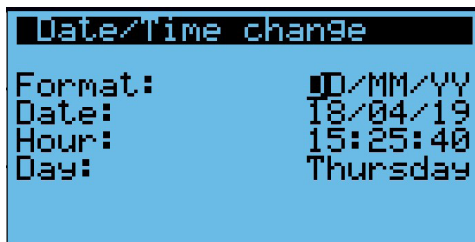

5. Press the Up/Down keys to cycle through the options. Once MM/DD/YY is displayed, press Enter. This will save the new value, and will move the cursor down to the date field.

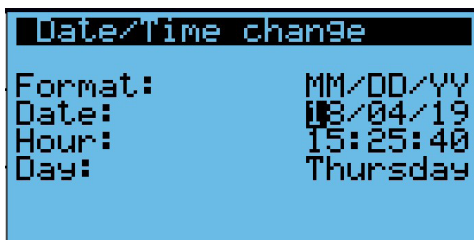

6. Press Escape three times to get back to the main status screen.

9.3 VIEWING ACTIVE ALARMS/ALARM LOGS

- From any screen, press the Alarm key. If there are active alarms, this will display a screen like this.

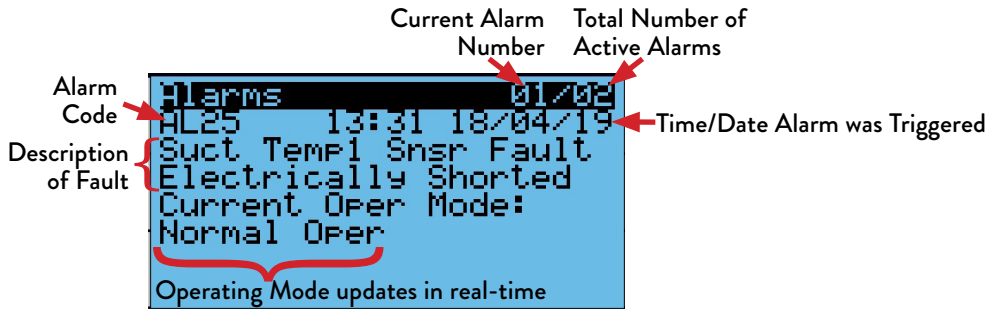

- Press Up/Down to cycle through all active alarms. The alarms are arranged in order of their alarm code (lowest to highest). One screen beyond last active alarm, the following screen will be displayed.
 - Note that if a fault condition is still present, resetting an alarm will have no effect. Active alarms will automatically be removed from the list when the fault condition is resolved.



- Press Enter to access the Alarm Log. This allows you to cycle through the 50 most recent alarms, whether they are active or if they've been resolved. These are arranged from newest to oldest. The Alarm Log screen is similar to the Active Alarm screen, except for a few differences:
 - The Alarm Log screen does not display the current operating mode
 - The Alarm Log screen shows both when the alarm was first triggered (Event: Start) and when the fault condition was resolved (Event: Stop).

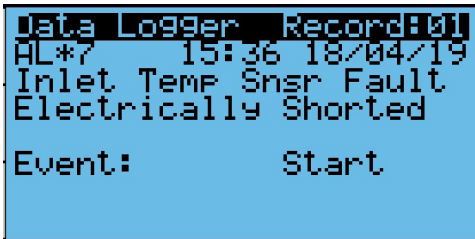

9.4 VIEWING UNIT RUN HOURS

1. From any screen, press Escape several times to return to the main status screen. Press Up/Down until the clock icon is displayed in the lower-right of the screen.



2. Press Enter to display the operating hours for the entire unit (compressor or fan), for the blower, and for the compressor.

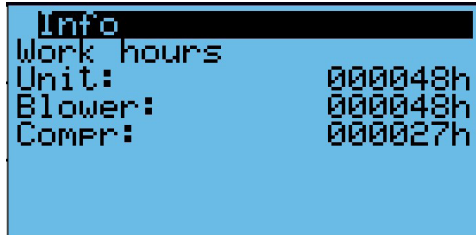

WIRING DIAGRAM OF THE QUEST 876 DEHUMIDIFIER

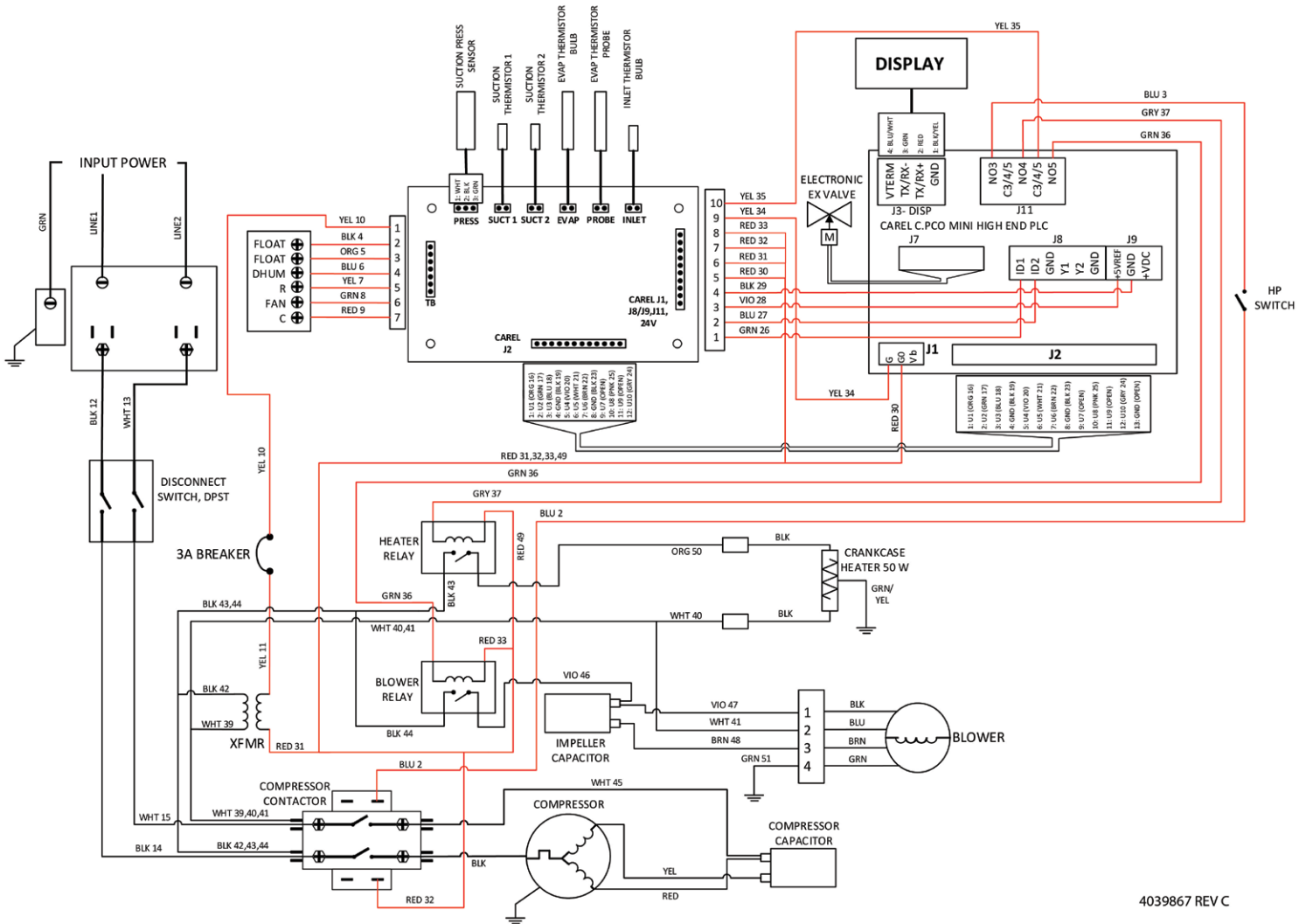

4039867 REV C

SERVICE PARTS LIST

Item	Part No	Description	Item	Part No	Description
1	4029507	CONTROL, HIGH PRESSURE	18	4038136	BEZEL, HANDLE (QTY 4)
2	4029575	RELAY (QTY 2)	19	4039864	WIRE HARNESS *NOT SHOWN
3	4039724	CONTACTOR	20	4038079	LUG, GROUND
4	4031406	TRANSFORMER	21	4038219	FOOT, RUBBER, 1.25" DIA (QTY 4)
5	4035949-07	CAPACITOR, COMP.	22	4038225-01	BRACKET, FOOT, RIGHT
6	4036559	CIRCUIT BREAKER	23	4038226-01	BRACKET, FOOT, LEFT
7	4039729	CLAMP, CAPACITOR (QTY 2)	24	4038215	BLOCK, WIRING
8	4041557-01	CAPACITOR, IMPELLER	25	4039948	PLC
9	4039729	THERMISTOR w/ CLAMP (QTY 2) *NOT SHOWN	26	4038233	FILTER 18x20x2 (QTY 2)
10	4039603	CPRSR	27	4039862	PRESSURE TRANSDUCER
11	4037702	FILTER, DRIER	28	4039932	CPRSR WIRE HARNESS (NOT SHOWN)
12	4039604-04	COIL, EVAP	29	4039863	CRANKCASE HEATER
13	4037699	THERMISTOR BULB (QTY 2) *NOT SHOWN	30	4041558	PLC DISPLAY
14	4039605-02	COIL, MICRO (QTY 4)	31	4041559	DISPLAY CABLE ASSEMBLY (NOT SHOWN)
15	4039661	EEV	32	4039875	PCB
16	4039606	FAN, MOTORIZED IMPELLER	33	4039866	SWITCH
17	4038135	HANDLE, POCKET (QTY 4)	34	4034716-08	THERMISTOR PROBE

OPTIONAL PARTS LIST

Part No	Qty	Description	Part No	Qty	Description
4028531	1	DEH 3000R Control, Remote	4038642	1	Kit, Intake Duct
4032220	1	Kit, Pump	4038641	1	Kit, Exhaust Duct

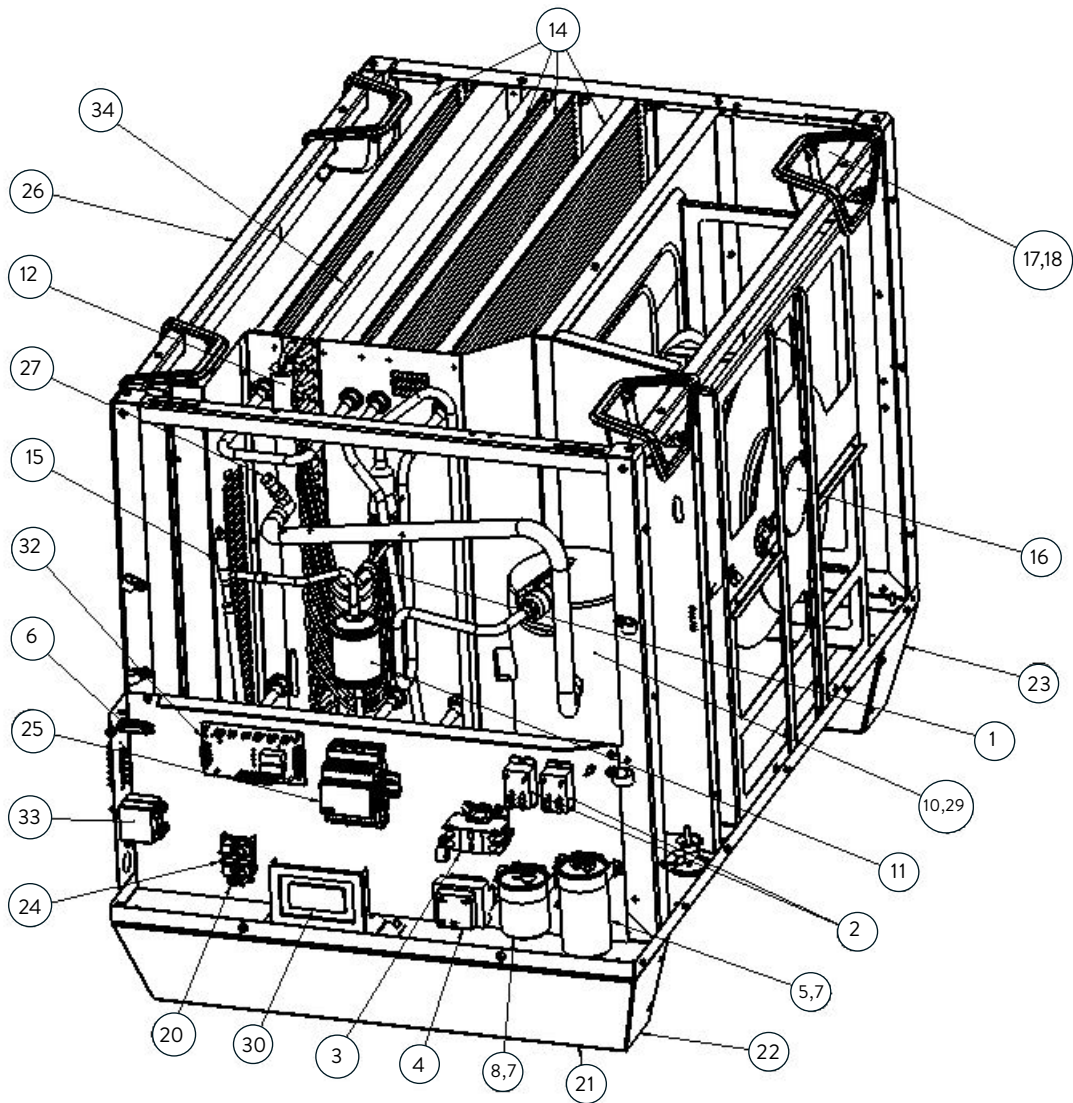

IMPORTANT WARRANTY INFORMATION

WARRANTOR:

Therma-Stor LLC
 4201 Lien Rd
 Madison, WI 53704
 Telephone: 1-800-533-7533

WHO IS COVERED: This warranty extends only to the original end-user of the Quest 876 Dehumidifier, and may not be assigned or transferred.

FIRST YEAR WARRANTY: Therma-Stor LLC warrants that, for one (1) year the Quest 876 Dehumidifier will operate free from any defects in materials and workmanship, or Therma-Stor LLC will, at its option, repair or replace the defective part(s), free of any charge.

SECOND THROUGH FIFTH YEAR WARRANTY: Therma-Stor LLC further warrants that for a period of five (5) years, the condenser, evaporator, and compressor of the Quest 876 Dehumidifier will operate free of any defects in material or workmanship, or Therma-Stor LLC, at its option, will repair or replace the defective part(s), provided that all labor and transportation charges for the part(s) shall be borne by the end-user.

END-USER RESPONSIBILITIES: Warranty service must be performed by a Servicer authorized by Therma-Stor LLC. If the end-user is unable to locate or obtain warranty service from an authorized Servicer, he should call Therma-Stor LLC at the above number and ask for the Therma-Stor LLC Service Department, which will then arrange for covered warranty service. Warranty service will be performed during normal working hours.

The End-user must present proof of purchase (lease) upon request, by use of the warranty card or other reasonable and reliable means. The end-user is responsible for normal care. This warranty does not cover any defect, malfunction, etc. resulting from misuse, abuse, lack of normal care, corrosion, freezing, tampering, modification, unauthorized or improper repair or installation, accident, acts of nature or any other cause beyond Therma-Stor LLC's reasonable control.

LIMITATIONS AND EXCLUSIONS: If any Quest 876 Dehumidifier part is repaired or replaced, the new part shall be warranted for only the remainder of the original warranty period applicable thereto (but all warranty periods will be extended by the period of time, if any, that the Quest 876 Dehumidifier is out of service while awaiting covered warranty service).

UPON THE EXPIRATION OF THE WRITTEN WARRANTY APPLICABLE TO THE Quest 876 DEHUMIDIFIER OR ANY PART THEREOF, ALL OTHER WARRANTIES IMPLIED BY LAW, INCLUDING MERCHANTABILITY AND FITNESS FOR A PARTICULAR PURPOSE, SHALL ALSO EXPIRE. ALL WARRANTIES MADE BY THERMA-STOR LLC ARE SET FORTH HEREIN, AND NO CLAIM MAY BE MADE AGAINST THERMA-STOR LLC BASED ON ANY ORAL WARRANTY. IN NO EVENT SHALL THERMA-STOR LLC, IN CONNECTION WITH THE SALE, INSTALLATION, USE, REPAIR OR REPLACEMENT OF ANY Quest Dual DEHUMIDIFIER OR PART THEREOF BE LIABLE UNDER ANY LEGAL THEORY FOR ANY SPECIAL, INDIRECT OR CONSEQUENTIAL DAMAGES INCLUDING WITHOUT LIMITATION WATER DAMAGE (THE END-USER SHOULD TAKE PRECAUTIONS AGAINST SAME), LOST PROFITS, DELAY, OR LOSS OF USE OR DAMAGE TO ANY REAL OR PERSONAL PROPERTY.

Some states do not allow limitations on how long an implied warranty lasts, and some do not allow the exclusion or limitation of incidental or consequential damages, so one or both of these limitation may not apply to you.

LEGAL RIGHTS: This warranty gives you specific legal rights, and you may also have other rights which vary from state to state.

SERIAL NUMBER



PART NUMBER

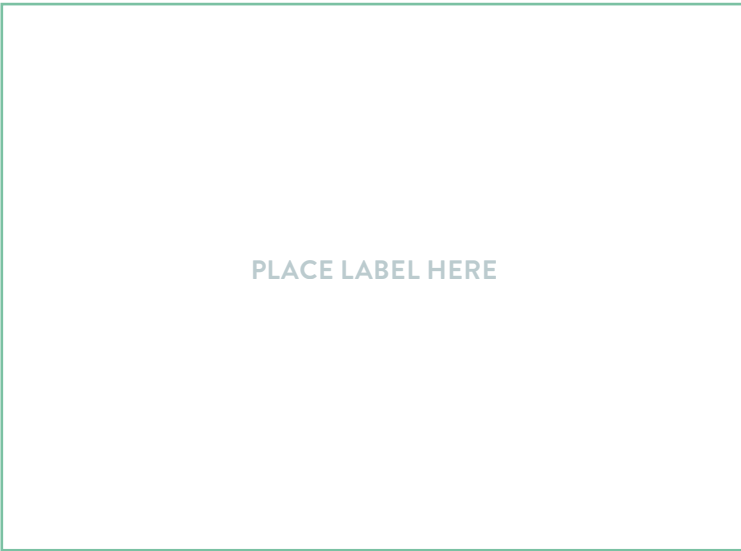

REGISTER YOUR NEW DEHUMIDIFIER

using the serial number and part number at thermastor.com/registration or scan code above

